



TAI-SAW TECHNOLOGY CO., LTD.

No. 3, Industrial 2nd Rd., Ping-Chen Industrial District,
Taoyuan, 324, Taiwan, R.O.C.

TEL: 886-3-4690038 FAX: 886-3-4697532

E-mail: tstsales@mail.taisaw.com Web: www.taisaw.com

Approval Sheet For Product Specification

Issued Date:

Product Name: SAW Filter 311.06MHz SMD 3.8×3.8mm

TST Parts No.: TA0615A

Customer Parts No.: _____

Company: _____
Division: _____
Approved by : _____
Date: _____

Checked by: _____ Asin Lin

Approval by: _____ Francis Chen

Date: _____ 2007/01/05



TAI-SAW TECHNOLOGY CO., LTD.

No. 3, Industrial 2nd Rd., Ping-Chen Industrial District,
Taoyuan, 324, Taiwan, R.O.C.

TEL: 886-3-4690038 FAX: 886-3-4697532

E-mail: tstsales@mail.taisaw.com Web: www.taisaw.com

SAW Filter 311.06 MHz

MODEL NO.: TA0615A

REV. NO.:2

A. MAXIMUM RATING:

1. Input Power Level: 10 dB_m
2. DC voltage: 10 V
3. Operating Temperature: -30°C to 85°C
4. Storage Temperature: -30°C to +85°C

RoHS Compliant
Lead free
Lead-free soldering

B. CHARACTERISTICS:

Item		Specification			
		Unit	Min.	Typ.	Max.
Center Frequency	F _c	MHz	-	311.06	-
Insertion Loss	IL _{min}	dB	-	1.7	3.0
Bandwidth	BW _{-3dB}	MHz	2	6	-
Ripple	F _c ± 1MHz		-	1	1.5
VSWR	F _c ± 1MHz		-	1.5	-
Absolute Attenuation(reference to 0 dB)					
F _c -11.7 ~ F _c -9.7	MHz	dB	40	45	-
F _c -22.4 ~ F _c -20.4	MHz	dB	50	55	-
Source impedance	Z _s	Ω	-	50	-
Load impedance	Z _L	Ω	-	50	-
Temperature coefficient		ppm/k		-37	

Note1. No matching network required for operation at 50Ω

C. MEASUREMENT CIRCUIT:

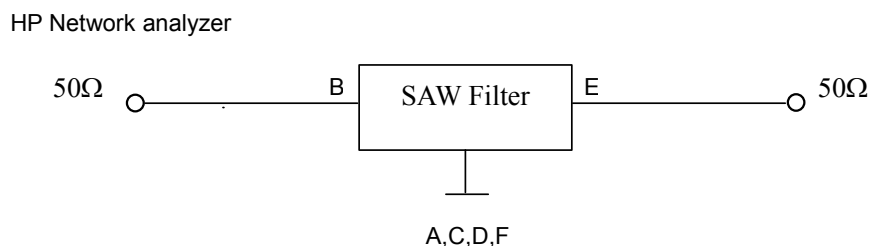

D. TRANSFER FUNCTION :

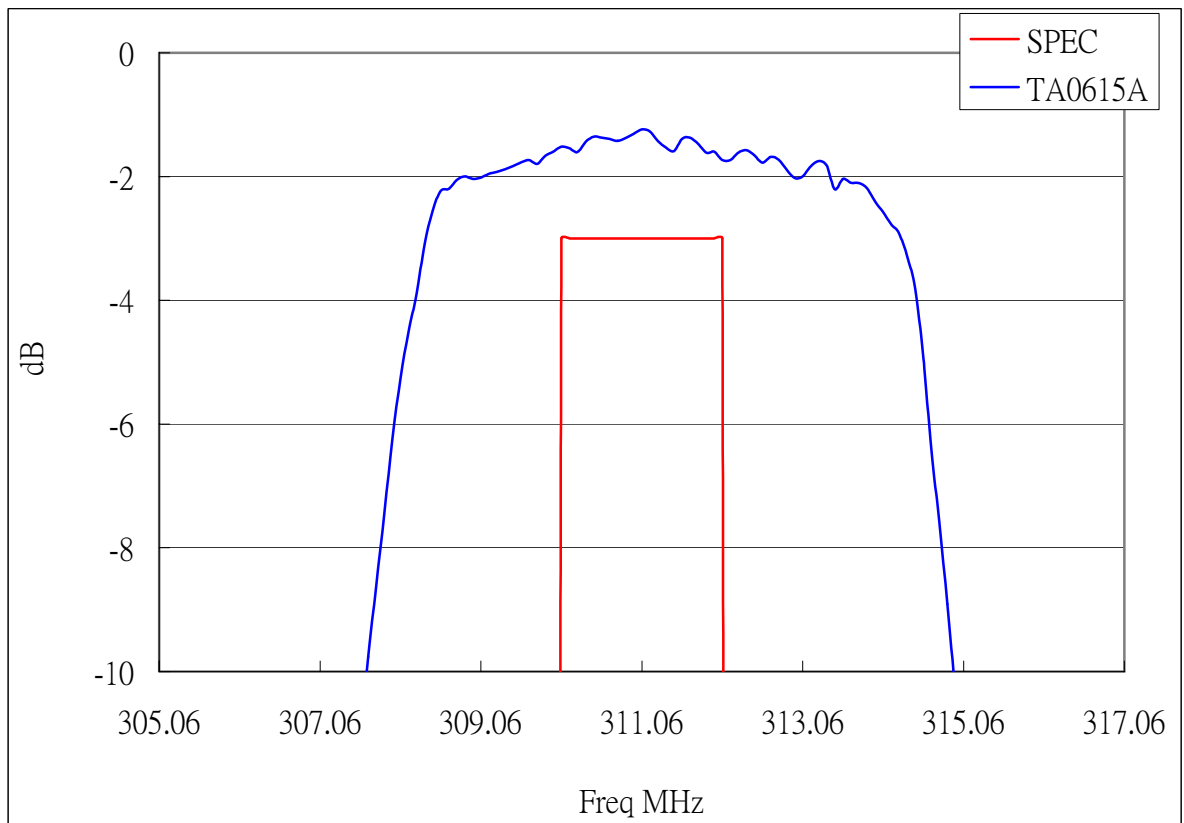
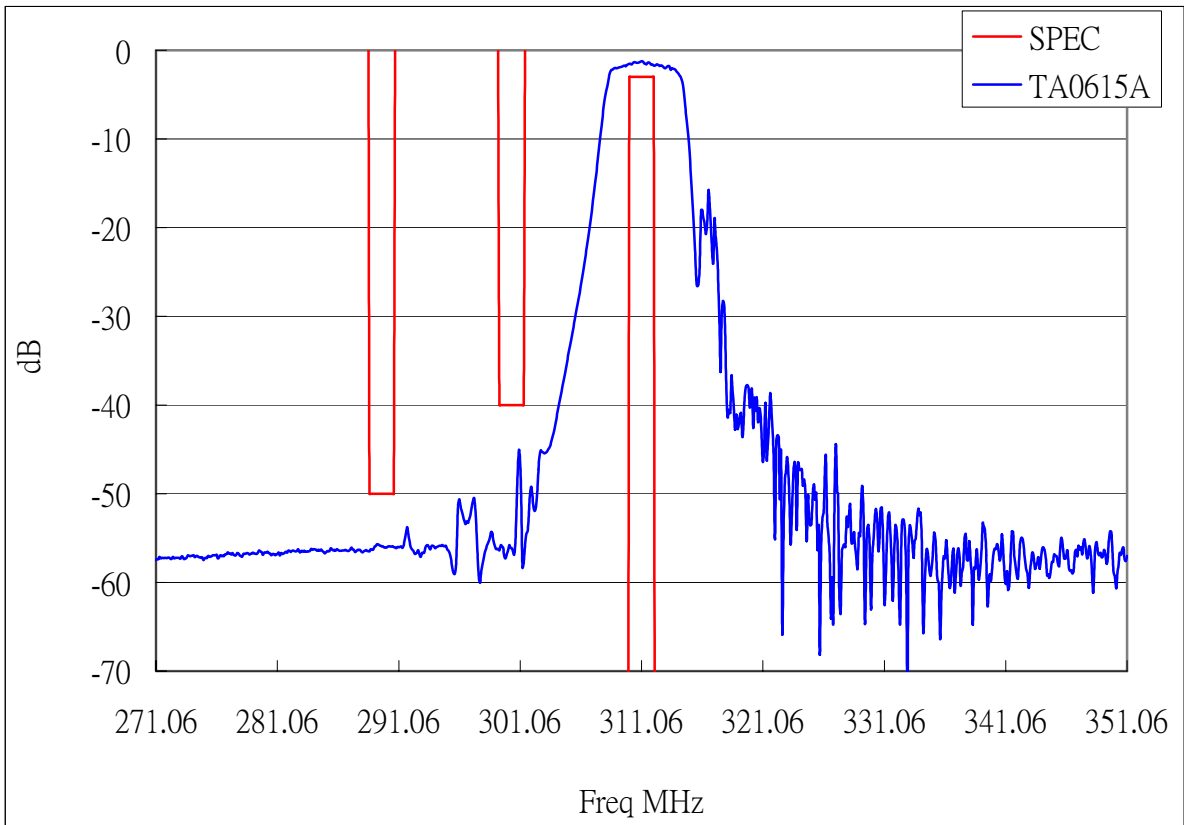

E.OUTLINE DRAWING:

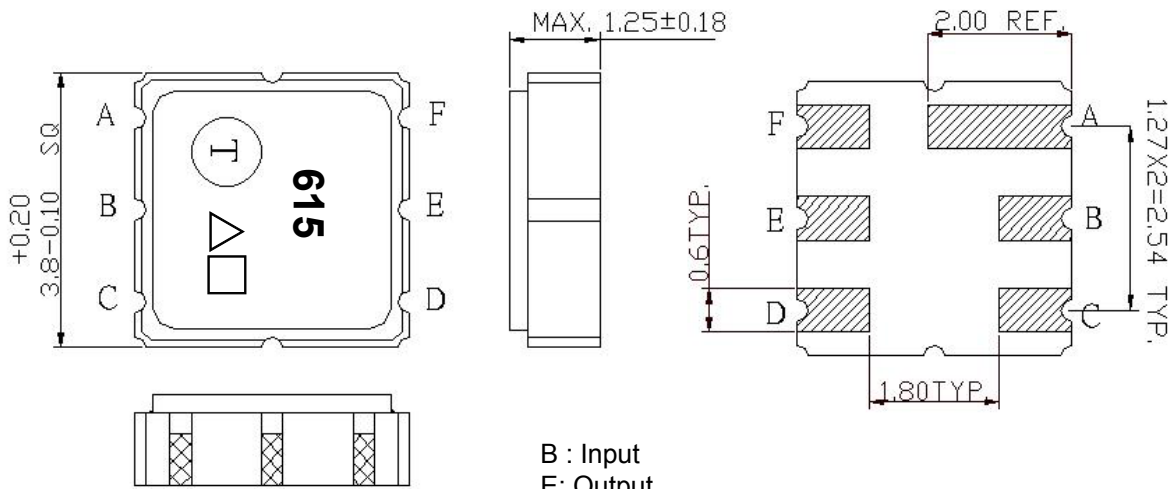

B : Input
 E: Output
 A,C,D,F Ground
 △:Year Code
 □: Date Code(Follow the table provided by planner each year.)
 Unit: mm

△ Product Year Code

Year	2005	2006
	2007	2008
	2009	2010
Product Code	A	a

F.PCB FOOTPRINT:

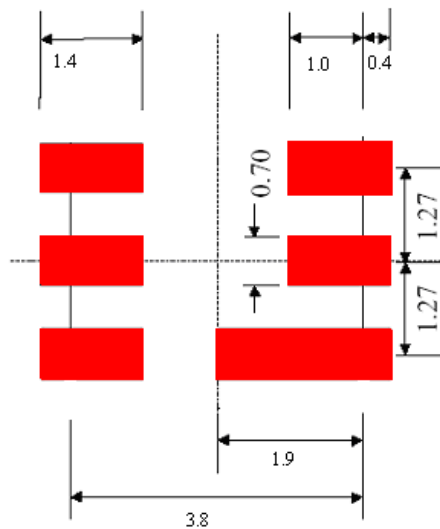

G. PACKING:

1. REEL DIMENSION

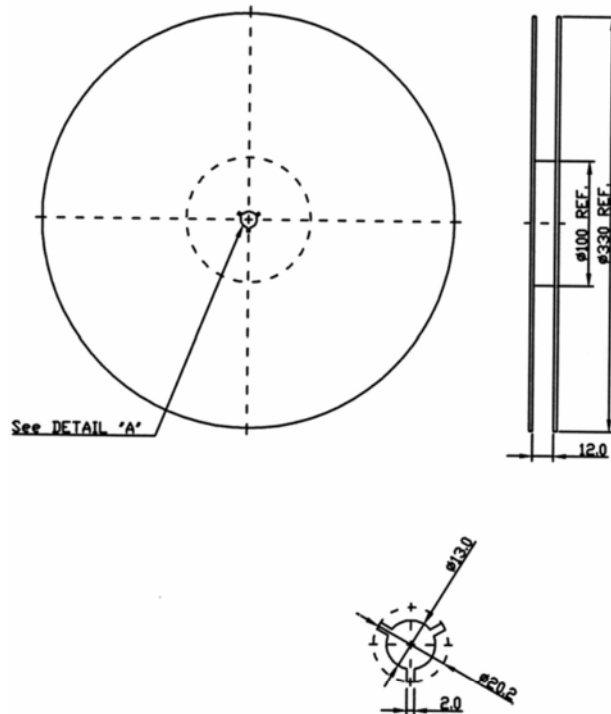

2. TAPE DIMENSION

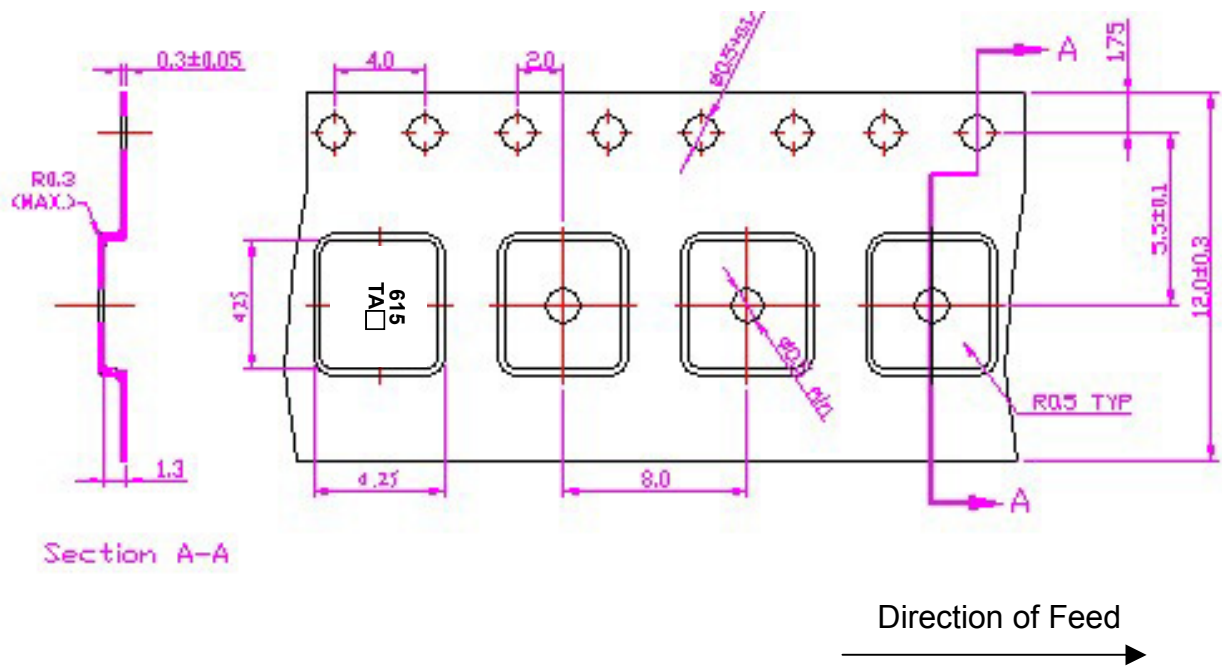

H. REFLOW PROFILE

